

1 INTRODUCTION

The 100 Series is designed to mount directly to all Stanadyne D Series mechanical fuel injection pumps. When the ADC100 electric actuator is installed on the fuel pump, an integral high-performance fuel control system results.

No external linkages or brackets are required and no extra Stanadyne parts are needed. In addition, when the governor system is de-energized, the ADC100 series can function as a fuel shutoff solenoid.

- Mounts directly to all Stanadyne D Series mechanical pumps
- No external linkages or brackets required
- Functions as a fuel shutoff solenoid when governor system is de-energized
- Faster response than competitive design

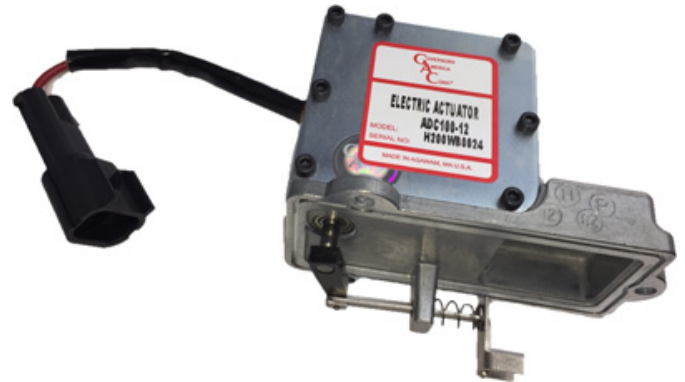

PART NUMBER	DESCRIPTION	Optional Purchase
ADC100-12	12 V DC / Packard Connector without Mating Connector / Includes GA102	--
ADC100-24	24 V DC / Packard Connector without Mating Connector / Includes GA102	--
FI280	100 Series - 90 degree return fuel fitting for ease of installation, all applications	Optional
GA102	100 Series - Actuator Mounting Gasket Spare (Included with Actuator)	Included
HW13-001	5-star Torx Bit - Pump Cover Screws (Service Tool)	Optional
CH1215	Wiring Harness - 6 ft [1.8 m] with EC1300 2-Terminal Packard Connector	Included
EC1300	Mating Connector - 2-Terminal Packard Connector	Included

2 SPECIFICATIONS

POWER INPUT		ENVIRONMENT	
Operating Voltage (Dedicated Coil)	12 or 24 V DC	Operating Temperature Range	-40 to +180 °F [-40 to +83 °C]
Normal Operating Current	1.9 A at 12 V DC 1.5 A at 24 V DC	Relative Humidity	up to 100 %
Maximum Current (Continuous)	2.7 A at 12 V DC 1.9 A at 24 V DC	All Surface Finishes	Fungus Proof and Corrosion Resistant
Coil Resistance	3.00 Ω nominal at 12 V DC 7.25 Ω nominal at 24 V DC	Agency	RoHS Compliant / CE
Direction of Travel	Increasing current increases fuel, pushing coupler forward	PHYSICAL	
		Dimensions	Section 3, Outline Diagram
		Weight	2.2 lbf [1.0 kgf]
		Mounting	Directly on STANADYNE DB, JDB, DC, DB2, DB4, DM2, and DM4 Series Pumps

3 INSTALLATION DIAGRAM

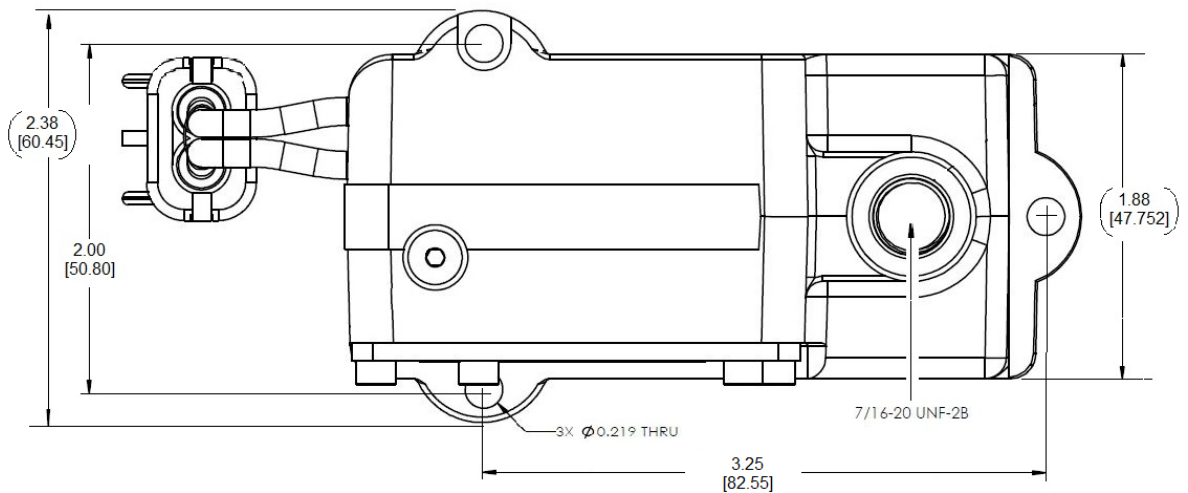
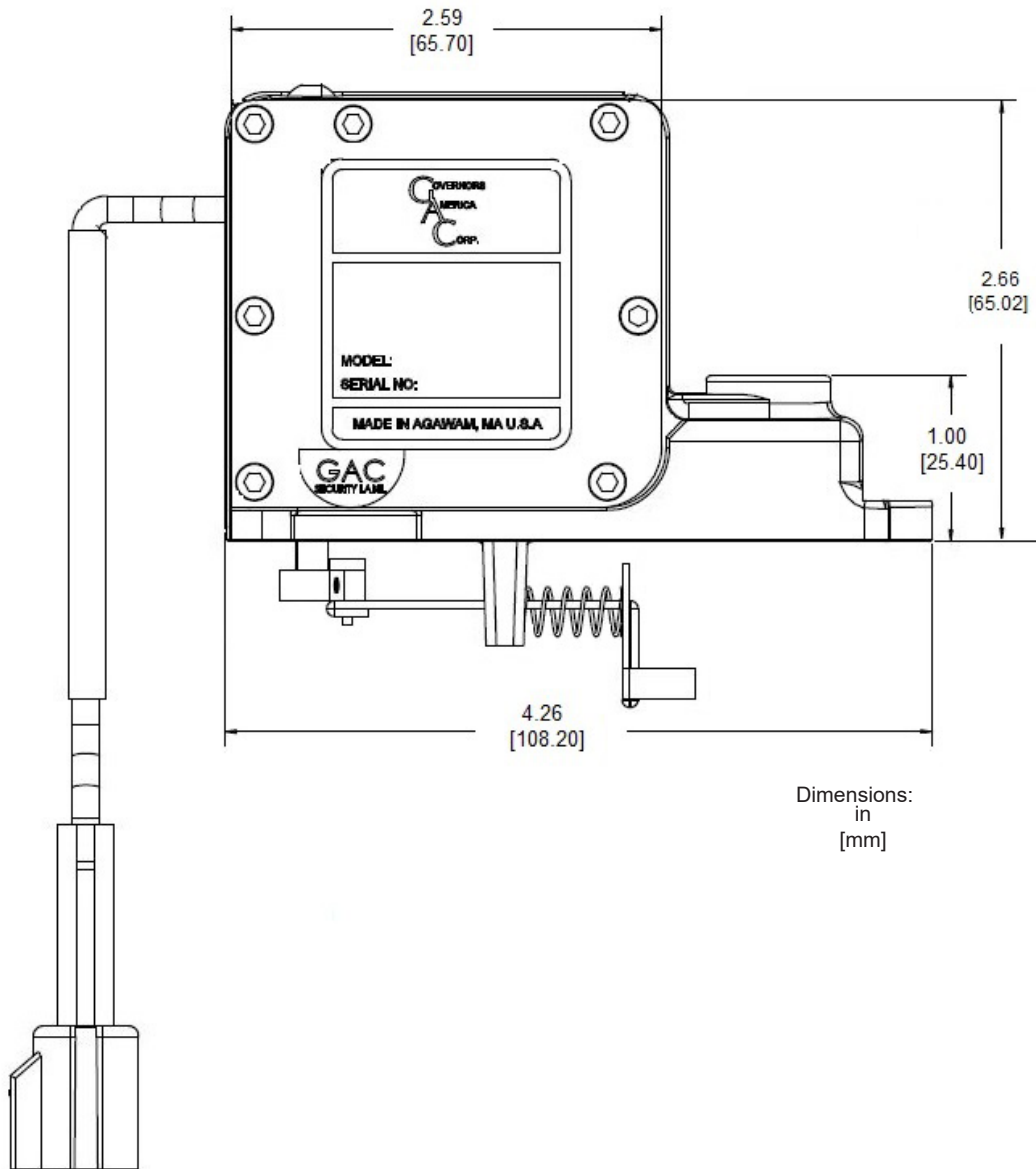

4 PREPARING THE FUEL PUMP

Prepare the fuel pump by first cleaning the pump and then removing the fuel and electric connections.

Before the fuel injection pump's Governor Cover can be removed and replaced by the ADC100 Series electric actuator, it is important for the outside of the pump to be clean.

1. If necessary, remove any dirt with a solvent. This will prevent contaminants from entering the pump. The cleaning solvent as well as fuel oil can be collected by placing a suitable container underneath the pump.
2. Disconnect the pump's electric shutoff solenoid wire from its connection point on the pump governor cover. This wire is no longer necessary and can be eliminated at its source.
3. Remove the fuel return line from the fuel return line connector. Save the connector.
4. Remove the three governor cover screws. The cover screws are replaced by mounting screws provided with the ADC100 Series actuator.
5. Remove the governor cover assembly with care to ensure that no dirt or debris enters the fuel injection pump.
6. Remove the return fuel fitting (housing pressure regulator assembly) from the governor cover. Retain the housing pressure regulator. You must reuse the housing pressure regulator to retain the housing pressure integrity.
7. Discard the metal formed gasket used in the original governor cover assembly. The old gasket must not be used with the new ADC100 Series actuator.
8. Place the ADC100 actuator gasket, GAC part number GA102, into the O-ring groove of the GAC actuator.
9. Additional installation steps are available if needed if you are replacing the [Woodward ST-125](#).

DISCONNECT SOLENOID AND FUEL LINE

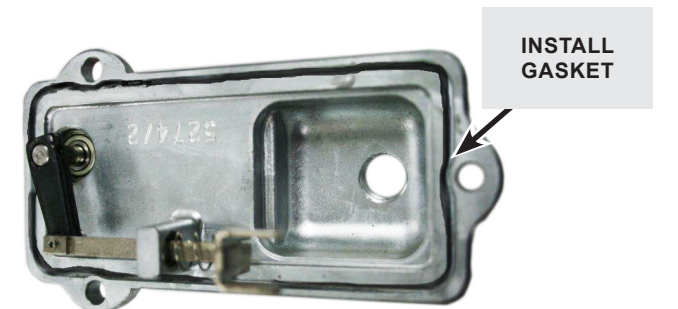
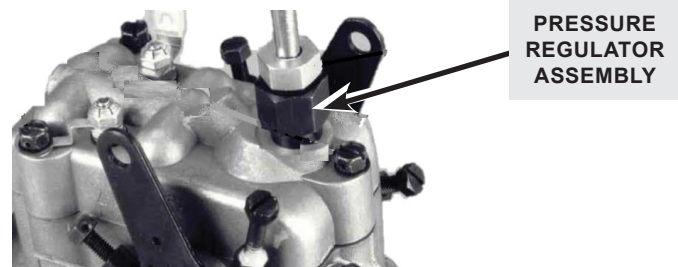
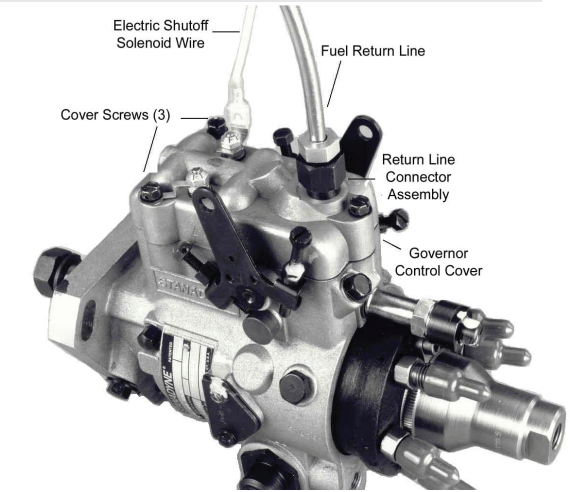

5 INSTALLING THE ACTUATOR

The following installation steps are specific to a Stanadyne pump. For other manufactures see your GAC representative for additional installation information.

1. Position the ADC100 actuator over the fuel injection pump with the tall end of the actuator slightly upward as close as possible to the front of the governor compartment. See our YouTube video for full details.



Improper engagement of the actuator to the governor linkage coupler could cause an engine over-speed condition.

2. Slide the ADC100 electric actuator toward the end of the fuel injection pump until the actuator's U-shaped coupler engages the pump's governor linkage hook. The actuator's U shaped coupler must engage the pump's governor linkage hook.

3. Check to see the coupler connection has been made by gently sliding back the actuator on a level plane (as shown in [YouTube](#) video) and meeting resistance from the opposing spring, indicating coupler is connected to linkage hook.

4. Once coupling is made, align the mounting screw holes between the electric actuator and the fuel injection pump and securely fasten the actuator to the pump, using the 3 screws provided with the actuator. Torque the screws to 21 ± 1 lbf-in.
5. Install the GAC FI280 90° fitting (not included).
6. Thread the original pump housings pressure regulator into the FI280 fitting.



SLIDE AT SLIGHT ANGLE TO CONNECT

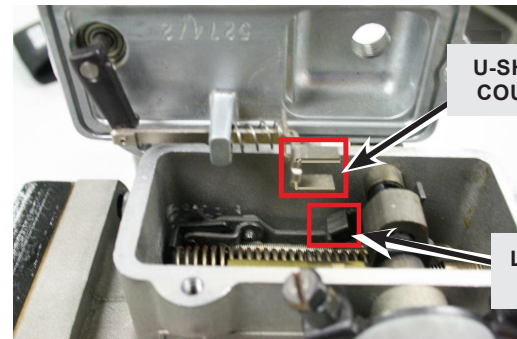

U-SHAPED COUPLER

LINKAGE HOOK



CHECK FOR RESISTANCE FROM OPPOSING SPRING TO ENSURE COUPLER-LINKAGE CONNECTION



7/16-20 THREAD CONNECTION

MOUNTING SCREW HOLES

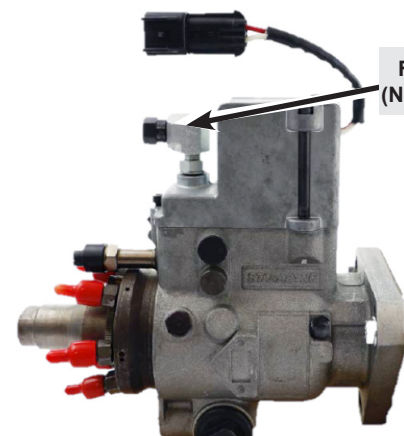

FI280 FITTING (NOT INCLUDED)

6 FUEL INJECTION PUMP SET-UP

NOTE

Prior to starting the engine, the pump's shut off lever, throttle lever and mechanical governor must be set to ensure compatibility with the electronic governor.

1. Secure the shut-off lever in the Run position, if the Stanadyne pump is equipped with one.
2. Lock the throttle lever in the Full Fuel position. This setting should be 10 – 12 % above the desired governed speed.
3. Adjust the pumps mechanical governor droop or speed by turning the speed - droop adjusting screw CW (from transfer pump end) until it stops. Then turn it CCW two turns. This adjustment provides compatibility between the mechanical governor and the electronic actuator.
4. Purge any air from the injection pump using the 3/32 hex head plug located on top of the actuator. See Section 3, [Outline Diagrams](#) for hex head location.

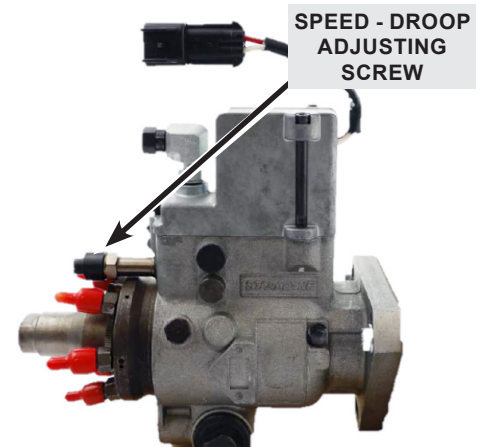
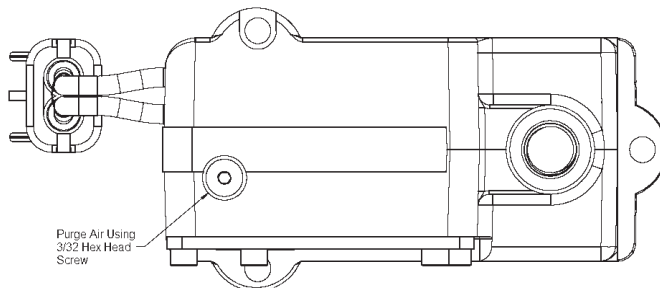

7 WIRING

The ADC100 Series is designed to have a dedicated coil for use in the 12 V DC operation and another dedicated coil for 24 V DC operation. These actuators are respectively identified as ADC100-12 and ADC100-24.

The output from the selected GAC speed control unit is connected to the ADC100 Series actuator using the GAC cable harness CH1215 included with the ADC100 actuator, or mating connector kit EC1300 (optional). See your specific speed control unit installation manual for wiring information.

CH1215 includes the pre-wired actuator mating half connector for the ADC100 Series actuator. The actuator connector offers a vibration resistant and environmentally sealed electrical connection.

8 TROUBLESHOOTING

If the governor system fails to operate and the actuator is suspected to be the problem, test the following resistance measurements:

Measure Coil Resistance Across Connector	Measure Coil Isolation Terminal to Actuator Housing
3.00 ±0.3 Ω 12 V DC	No Continuity
7.25 ±0.3 Ω 24 V DC	

If resistance is not the issue, complete the following checks:

1. Remove the ADC100 from the pump.
2. Move the U-shaped coupler arm back and forth to ensure it moves and returns freely without binding. Make sure the arm is not bent or deformed.
3. Energize the actuator referencing the speed control manual or momentarily connect the actuator to the battery to see if it moves and returns.
4. Following the steps in Section 4, [Preparing the Fuel Pump](#), and Section 5, [Installing the Actuator](#), reconnect the ADC100 to the pump.

If the actuator passes these tests, the problem is elsewhere in the governing system. Refer to your speed control unit installation manual's troubleshooting section for more information.